



RPS/DPS8000H

Hydrogen Focused High Accuracy Resonant Pressure Sensor

Since 1972, Druck has manufactured precision pressure sensors with a capability to meet critical applications in industrial, aerospace, oil and gas, and research environments. Today, Druck is part of Baker Hughes and has continually worked to develop and improve on the performance of our pressure sensors to meet our customers' requirements.

The RPS/DPS8000H combines ground-breaking TERPS technology and a hydrogen barrier coating to create the most accurate and stable hydrogen-capable pressure sensor on the market today. TERPS is a resonant silicon pressure sensor technology platform that provides an order of magnitude greater accuracy and stability than current pressure measurement technologies. TERPS technology also extends the pressure range capability to high pressures and, by incorporating true pressure media isolation, greatly improves its suitability for use in harsh environments.

Challenges in hydrogen pressure measurement

As a market leader in pressure measurement for the past 50 years, Druck is fully aware of the challenges that hydrogen applications pose for pressure sensors due to the unique behaviour of the medium. Exposure to hydrogen gas can impact the performance of a pressure sensor, specifically via the processes of hydrogen permeation and embrittlement, hence key design aspects need to be considered with a hydrogen pressure sensor to maintain accuracy and stability.

In addition to providing the performance and packaging improvements available with TERPS, the RPS/DPS8000 product line takes advantage of best practices to offer a wide range of pressure and electrical connections to enable a level of customization for your specific requirements never before available in the performance class of this sensor.

The combination of the power of the TERPS technology and the quality, reliability and flexibility of the RPS/DPS8000H Series offers a truly unique solution for high accuracy and high stability pressure measurement in a hydrogen-rich media.

Features

- High Precision, $\pm 0.01\%$ FS over compensated temperature range
- High Stability, ± 100 ppm FS/year
- Wide temperature range, up to -40°C to $+125^{\circ}\text{C}$ (-40° to 257°F)
- Media isolated construction, suitable for use in harsh environments
- Suitable for use in hydrogen rich media
- Multiple Output configurations, RS-232, RS-485, USB 2.0, CAN Bus, Frequency & Diode (TTL)
- Wide selection of pressure & electrical connections to suit specific requirements

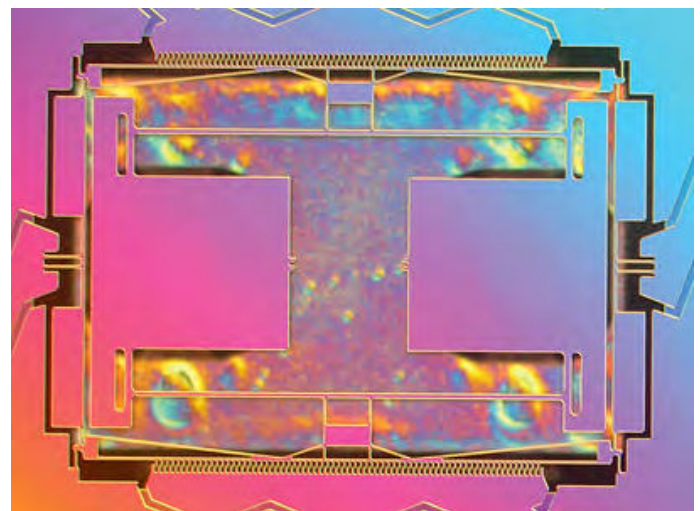

Specifications

Measurement

Base Pressure Ranges

- 0 to 7 bar (0 to 101 psi) absolute
- 0 to 14 bar (0 to 203 psi) absolute
- 0 to 20 bar (0 to 290 psi) absolute
- 0 to 35 bar (0 to 507 psi) absolute
- 0 to 70 bar (0 to 1015 psi) absolute
- 0 to 100 bar (0 to 1450 psi) absolute
- 0 to 200 bar (0 to 2900 psi) absolute

Calibrated Ranges

Any zero-based range between 2 and 200 bar (29 to 2900 psi) can be specified. (Performance will be of the full scale of the base pressure range selected.)

The lowest calibrated pressure is 35 mbar absolute.

Overpressure

1.5X FS

Sensor Failure Pressure

2.0X FS

Pressure Containment

- 70 bar (1,015 psi) for ranges to 7 bar (101 psi),
- 200 bar (2,900 psi) for ranges to 100 bar (1,450 psi),
- 700 bar (10,150 psi) for ranges to 200 bar (2,900 psi)

Supply and Output

Electronics Option	Supply Voltage (V DC)	Output	Current Consumption ⁽²⁾ (mA)
1	5 to 32	Frequency & Diode TTL ^(1,3,4)	3.5
A	9 to 28	RS485	16.5 quiescent, 32 max
B	9 to 28	RS232	16.5 quiescent, 32 max
C	9 to 28	CAN Bus	16.5 quiescent, 32 max
U	4.8 to 5.2	USB 2.0	40 quiescent, 100 max

1. Jitter less than 20 ns
2. Full temperature range
3. Square wave pressure signal, 25 kHz nominal, 4-10 kHz span
4. Forward voltage diode, 0.5 to 0.7 V @ 25°C (77°F), typically -2 mV/°C nominal

Response Time

< 300 msec for pressure change from 10% to 90% FS

Supply Response

TTL: Accurate to specification within 500 ms of power up, over all operating temperatures

RS232/RS485/CAN Bus/USB: Accurate to specification within 10 min of power-up

Electrical Protection

RS232/485/CAN Bus/TTL: Connecting Vsupply and GND between any combinations of pins on the connector will not damage the unit

Insulation

RS232/485/CAN Bus/TTL:

> 100 MOhm @ 500 Vdc between all pins and case.

Performance

There are two levels of performance specification:

- Standard
- Improved

Specifications include combined effects of non-linearity, hysteresis, repeatability and temperature errors over the compensated temperature range, and over the base pressure range of 35 mbar to the full scale pressure.

Accuracy Code	Precision
A1- Standard	0.02% FS
A2- Improved	0.01% FS

- For Frequency & Diode output, the above accuracies are achievable by using a polynomial curve fit algorithm and coefficient data supplied with sensor.
- Sensors are calibrated against standards traceable to UKAS operating to better than 100 ppm.

Compensated Temperature Ranges:

There are three compensated temperature ranges available:

- -10 to +50°C
- -40 to +85°C
- -40 to +125°C (TTL and CAN bus only)

Temperature Effects

All temperature effects are included in the accuracy statement.

Long Term Stability

Standard: ±0.02% FS/annum

Improved: ±0.01% FS/annum

Note: Unless otherwise specified, specifications are at the reference conditions of 25°C (77°F) ±5°C (±9°F) and 1 bar (14 psi).

Orientation (g) Sensitivity

Less than 0.2 mbar/g

Physical Specifications

Storage Temperature Range

As compensated temperature range.

Operating Temperature Range

As compensated temperature range.

Pressure Media

Fluids compatible with 316L stainless steel and gold. Do not use with oxygen rich media or other strong oxidizing agents. This product contains materials or fluids that may degrade or combust in the presence of strong oxidizing agents.

Ingress Protection

See Electrical Connector section

Vibration

BS EN 60068-2-6 (2008) Sine sweeps 5 Hz to 2 kHz, levels to 20gn

BS EN 60068-2-64 random 10 Hz to 2kHz to 4gn RMS for 1 hour each axis

Less than 0.02% FS effect at any time

Shock

DO-160E 9 (Figure 7.2) 20 gn 11 ms terminal saw-tooth profile

Humidity

MIL-STD-810D Method 507.2 Procedure III (Aggravated humidity environment, 65°C, 95% RH)

Pressure Connector

Available Options are:

- G1/4 Female*
- G1/4 Male Flat
- G1/4 Male 60° Internal Cone
- G1/8 Male 60° Internal Cone
- 1/4 NPT Female*
- 1/4 NPT Male
- 1/8 NPT Male
- M20 x 1.5 Male (3mm bore)
- M14 x 1.5 60° Internal Cone
- M12 x 1 Internal Cone
- 7/16-20 UNJF Male 74° External Cone
- G1/2 Male*
- G1/4 Quick Connect
- 1/2 NPT Male
- G1/4 Male Flat Long
- 7/16-20 UNJF Female
- 7/16-20 UNF Male Short Flat
- 3/8-24 UNJF
- 1/4 VCR Female
- 1/4 VCR Male*

* choose one of these connectors for pressure ranges above 104 bar.

Other pressure connectors may be available. Contact Baker Hughes to discuss your requirement.

Please ensure that only the intended sealing face is used when mounting the sensor. Failure to comply with this requirement may affect performance or calibration accuracy.

Male threaded pressure connectors must not be sealed or constrained against the face at the base of the thread. The forward cone or flat face should always be used, as indicated below.

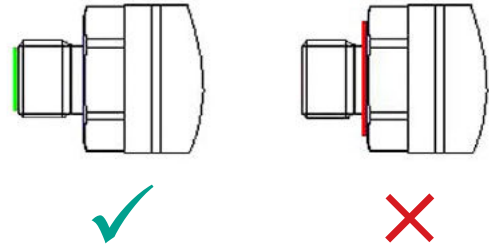

Electrical Connector

Code No.	Description	Max Operating Temp. Range		IP Rating
		°C	°F	
0	No Connector	-55 to +125	-67 to +257	-
1	Cable Gland	-40 to +80	-40 to +176	65
2	Raychem Cable	-55 to +125	-67 to +257	65
6	Bayonet MIL-C-26482	-55 to +125	-67 to +257	*
C	1/2 NPT Conduit	-40 to +80	-40 to +176	65
G	M12 X "15"-pin	-55 to +125	-67 to +257	*
H	PTFE Cable (Orange)	-55 to +125	-67 to +257	54
M	Micro USB socket	-40 to +85	-40 to +185	-

* Hermetically sealed connectors with a maximum leak rate of 1×10^{-6} cc/s at 1 atmosphere. High IP rated mating connectors are available.

Certifications

- CE Marked
- RoHS
- EMC Standards:
 - BS EN 61000-6-1: 2007, Susceptibility – Light Industrial.
 - BS EN 61000-6-2: 2005, Susceptibility – Heavy Industrial.
 - BS EN 61000-6-3: 2007, Emissions – Light Industrial.
 - BS EN 61000-6-4: 2007, Emissions – Heavy Industrial.
 - BS EN 61326-1: 2013, Electrical Equipment for Measurement, Control and Laboratory Use – EMC requirements.
 - BS EN 61326-2-3:2013 Requirements for pressure transducers.
- ATEX/IECEx/UKEX Ex ec nC IIC T3 Gc
CSA Class I Division 2 Groups C,D T3
(Canbus and M12 connector only).

Connection Details

Option	Code	Connection	Function			
			Frequency & Diode	Digital – RS485	Digital – RS232	Digital – CAN Bus
Flying Leads	0	RED	SUPPLY +VE	SUPPLY +VE	SUPPLY +VE	SUPPLY +VE
		YELLOW	FREQ	RS485 B	Rx	CAN Hi
		GREEN	+VE TEMP	RS485 A	Tx	CAN Lo
		BLUE	GROUND	GROUND	GROUND	SUPPLY -VE
		BLACK	-VE TEMP	-	-	CAN OV
		ORANGE	EEPROM	-	-	-

Option	Code	Connection	Function			
			Frequency & Diode	Digital – RS485	Digital – RS232	Digital – CAN Bus
CABLE	I, C	RED	SUPPLY +VE	SUPPLY +VE	SUPPLY +VE	SUPPLY +VE
		YELLOW	FREQ	RS485 B	Rx	CAN Hi
		BLUE	+VE TEMP	RS485 A	Tx	CAN Lo
		WHITE	GROUND	GROUND	GROUND	SUPPLY -VE
		BLACK	-VE TEMP	-	-	CAN OV
		ORANGE	EEPROM	-	-	-
		SCREEN	-	-	-	-

Option	Code	Connection	Function			
			Frequency & Diode	Digital – RS485	Digital – RS232	Digital – CAN Bus
RAYCHEM	2	RED	SUPPLY +VE	SUPPLY +VE	SUPPLY +VE	SUPPLY +VE
		WHITE	FREQ	RS485 B	Rx	CAN Hi
		GREEN	+VE TEMP	RS485 A	Tx	CAN Lo
		BLUE	GROUND	GROUND	GROUND	SUPPLY -VE /CAN OV
		BLACK	EEPROM	-	-	-
		SCREEN	-	-	-	-

Option	Code	Connection	Function			
			Frequency & Diode	Digital – RS485	Digital – RS232	Digital – CAN Bus
MIL-C	6	A	SUPPLY +VE	SUPPLY +VE	SUPPLY +VE	SUPPLY +VE
		B	FREQ	RS485 B	Rx	CAN Hi
		C	+VE TEMP	RS485 A	Tx	CAN Lo
		D	GROUND	GROUND	GROUND	SUPPLY -VE
		E	EEPROM	-	-	-
		F	-VE TEMP	-	-	CAN OV

Option	Code	Connection	Function			
			Frequency & Diode	Digital – RS485	Digital – RS232	Digital – CAN Bus
MI2	M	1	SUPPLY +VE	SUPPLY +VE	SUPPLY +VE	N/C
		2	FREQ	RS485 B	Rx	CAN Hi
		3	GROUND	GROUND	GROUND	SUPPLY -VE /CAN OV
		4	+VE TEMP	RS485 A	Tx	CAN Hi
		5	EEPROM	-	-	CAN Lo

Option	Code	Connection	Function			
			Frequency & Diode	Digital – RS485	Digital – RS232	Digital – CAN Bus
PTFE	H	RED	SUPPLY +VE	SUPPLY +VE	SUPPLY +VE	SUPPLY +VE
		YELLOW	FREQ	RS485 B	Rx	CAN Hi
		GREEN	+VE TEMP	RS485 A	Tx	CAN Lo
		BLUE	GROUND	GROUND	GROUND	SUPPLY -VE
		BLACK	EEPROM	-	-	-
		WHITE	-VE TEMP	-	-	CAN OV
		SCREEN	CASE	CASE	CASE	CASE

	Frequency & Diode	Digital – RS232	Digital – RS485	CAN Bus	USB ¹
Maximum Cable length (m)	10	10	1000	1000	2

Note¹: Cable not provided with USB option.

Dimensional Drawings

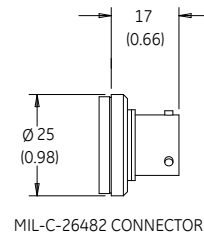
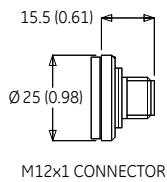
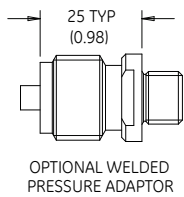
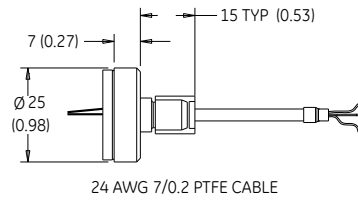
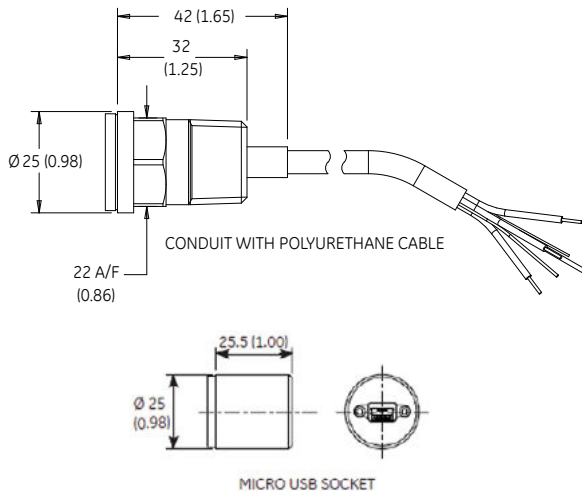
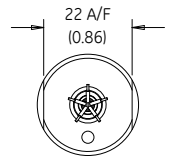
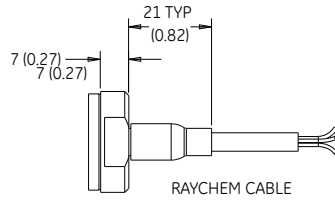
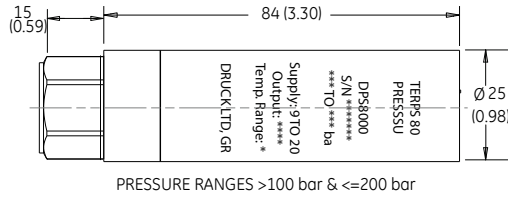
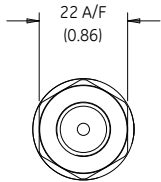
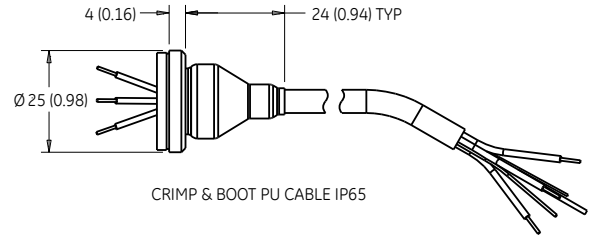
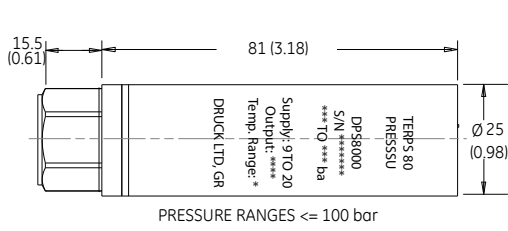
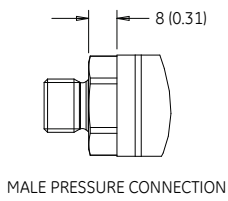

Notes:

1. All dimensions are nominal lengths and are subject to change.
2. All dimensions are in millimeters (inches).
3. Other pressure and electrical connectors may be available, please contact Druck.

Ordering Information

(1) Select model code

Main Product Variant

RPS Resonant Pressure Sensor – Frequency & Diode Output **(Note 1)**

DPS Digital Pressure Sensor – Digital Output **(Note 1)**

Diameter, Material and Isolation

80 25mm Stainless Steel Oil isolated

Electrical Connector

0 No Electrical Connector (Flying leads length >100mm)

1 Polyurethane Cable IP65

2 Raychem Cable

6 MIL-C-26482 (6-pin Shell Size 10)

C 1/2" NPT Conduit with Polyurethane Cable (Non-Exd Only)

G M12x1 5-Pin

H Orange PTFE Cable

M Micro USB socket **(Note 3)**

Output Option **(Note 6)**

1 Frequency & Diode (TTL)

A RS485

B RS232

C CAN Bus

U USB 2.0 **(Note 4)**

Hydrogen Use

H

Compensated Temperature Range

TA -10 to +50 °C

TB -40 to +85 °C

TC -40 to +125 °C **(Note 2)**

Accuracy

A1 - Standard 0.02%

A2 - Improved 0.01%

Calibration

CC Full Thermal Calibration

Hazardous Area Approval

H0 None

HU IECEx/ATEX/C&US Ex ec nC **(Note 6)**

Pressure Connector

PA G1/4 Female **(Note 5)**

PB G1/4 Male Flat

PC G1/4 Male 60° internal Cone

PD G1/8 Male 60° internal Cone

PE 1/4 NPT Female **(Note 5)**

PF 1/4 NPT Male

PG 1/8 NPT Male

PH M20x1.5

PJ M14x1.5 60° Internal Cone

PK M12x1 Internal Cone

PL 7/16-20 UNJF Male 74 degree external cone

PN G1/2 Male **(Note 5)**

PQ G1/4 Quick Connect

PR 1/2 NPT Male

PT G1/4 Male Flat Long

PV 7/16-20 UNJF Female

PX 7/16-20 UNF Male Flat

PY 3/8-24 UNJF

RA 1/4 VCR Female

RF 1/4 VCR Male **(Note 5)**

RPS 80 4 1 H - TA - A2 - CC - H0 - PA [Typical Model Code]

Note 1: RPS variants require Output Option Code '1'. DPS variants require Output Option Code 'A', 'B', 'C' or 'U'.

Note 2: Requires Output Option Code '1' or 'C' and Electrical Connector Codes '0', '2', '6', 'G', or 'H'.

Note 3: Only available with USB output option.

Note 4: Only available with micro USB socket connector.

Note 5: Choose one of these connectors for pressure ranges above 104 bar.

Note 6: Only available with electrical connector option G and CANbus output.

Ordering Information (cont.)

2) State pressure range and units (e.g., 0 to 20 bar, 0 to 100 psi):

Unit options are:

Symbol	Description
bar	bar
mbar	millibar
psi	pounds/sq. inch
Pa	Pascal
hPa	hectoPascal
kPa	kiloPascal
MPa	megaPascal
mmH ₂ O	mm water
cmH ₂ O	cm water
mH ₂ O	metres water
inH ₂ O	inches water
ftH ₂ O	feet water
mmHg	mm mercury
inHg	inches mercury
kgf/cm ²	kg force/sq. cm
atm	atmosphere
Torr	torr

3) State cable lengths and units e.g., 1 m cable, 3 ft cable (only required on certain electrical connectors):

Note 6: Maximum Cable length: (1) Frequency & Diode – 10 m, (A) RS485 – 1000 m, (B) RS232 – 10 m, (C) CAN Bus – 1000 m. Integer values only, e.g. 1m (3 ft) cable. Minimum cable length is 1m (3 ft) if cable is supplied.

Typical order examples:

RPS 8011H-TA-A1-CC-H0-PA, 0-7 bara, 5 m cable

DPS 806AH-TB-A2-CC-H0-PL, 0-1,000 psia

© Copyright 2023. Baker Hughes Company. This material contains one or more registered trademark of Baker Hughes Company and its subsidiaries in one or more countries. All third-party product and company names are trademarks of their respective holders.

920-713B

BHCS39429

(11/2023)

Baker Hughes 

[druck.com](https://www.druck.com)